

Hygienic Touch-Free
Water Efficient and Reliable
Cold or Pre-Mixed Water



Infrared Automatic Technology

Intelligent automatic logic system sensor controls the flow, water starts / stops when hands are in active range. Adjustable sensing distance and time delay can be set.

European Design and Manufacture

Long standing European manufacturer- high quality electronics combined with elegant aesthetics.

Automatic Water Stop Functionality

Perfect in areas where control of water usage is necessary, a handy setting allowing water to cease supply after 5 minutes of continuous flow.

Arc

Supply Specification	Faucet with electronics, electromagnetic valve, connecting hoses, angle valve with filter
Finish	Chrome
Water Temperature	For cold or premixed water (thermostatic mixing valve available)
Power Supply	Mains – 230V AC, 50 Hz (input) – 24V (output)
Control	Infrared sensor
Voltage	Mains 24V DC, 7W
Active Range	Standard 0.13 - 0.19 m, START / STOP program 0.25 - 7.75 secs
Recommended Flow Pressure	0.1 - 0.6 Mpa (1-6 Bar)
Rate of Flow	3.8 l/min (6 l/min or 1.9L/m available on request)
Water Inlet	Male thread G 1/2"
Dimensions	Height 136mm, Depth 158mm, Tap Ø 50mm, Hole Ø 35mm, Nosing 116mm, Discharge height 107mm
Warranty	24 Months
Product Code	SST01AC (Mains)

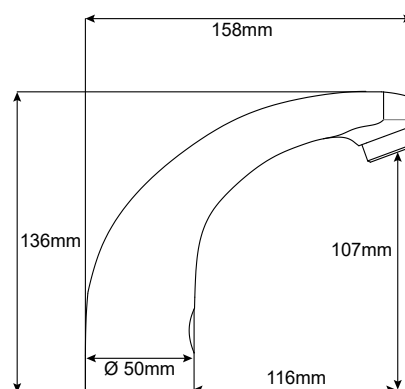

Husa

Supply Specification	Faucet with electronics, electromagnetic valve, Y-piece, connecting hoses, angle valve with filter
Finish	Chrome
Water Temperature	For cold or premixed water (thermostatic mixing valve available)
Power Supply	Mains – 230V AC, 50 Hz (input) – 24V (output) Battery – 6V (4x AA alkaline batteries)
Control	Infrared sensor
Voltage	Mains – 24V DC, 14W, - Battery 6V, 6W
Active Range	Standard 0.2 - 0.26 m, START / STOP program 0.25 - 7.75 secs
Recommended Flow Pressure	0.1 - 0.6 Mpa (1-6 Bar)
Rate of Flow	3.8 l/min (6 l/min or 1.9L/m available on request)
Water Inlet	Male thread G 1/2"
Dimensions	Height 346mm, Depth 210mm, Tap Ø 50mm, Hole Ø 35mm, Nosing 190mm, Discharge height 230mm
Warranty	24 Months
Product Code	SST08AC (Mains) SST08DC (Battery)

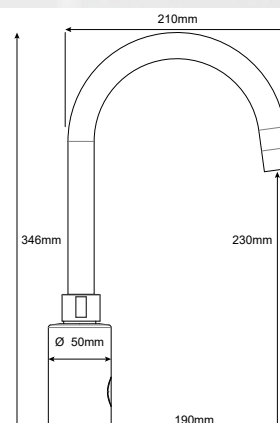

Austere

Supply Specification	Faucet with electronics, electromagnetic valve, connecting hoses, angle valve with filter
Finish	Chrome
Water Temperature	For cold or premixed water (thermostatic mixing valve available)
Power Supply	Mains – 230V AC, 50 Hz (input) – 24V (output) Battery – 6V (4x AA alkaline batteries)
Control	Infrared sensor
Voltage	Mains 24V DC, 7W – Battery 6V, 3W
Active Range	Standard 0.13 - 0.19 m, START / STOP program 0.25 - 7.75 secs
Recommended Flow Pressure	0.1 - 0.6 Mpa (1-6 Bar)
Rate of Flow	3.8 l/min (6 l/min or 1.9L/m available on request)
Water Inlet	Male thread G 1/2"
Dimensions	Height 152mm, Depth 145mm, Tap Ø 54mm, Hole Ø 35mm, Nosing 97mm, Discharge height 128mm
Warranty	24 Months
Product Code	SST56AC (Mains) SST56DC (Battery)

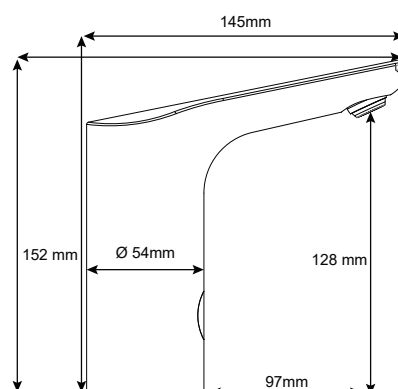

Austere - Black

Supply Specification	Faucet with electronics, electromagnetic valve, connecting hoses, angle valve with filter
Finish	Matte black powder coat over brass
Water Temperature	For cold or premixed water (thermostatic mixing valve available)
Power Supply	Mains – 230V AC, 50 Hz (input) – 24V (output)
Control	Infrared sensor
Voltage	Mains 24V DC, 7W
Active Range	Standard 0.13 - 0.19 m, START / STOP program 0.25 - 7.75 secs
Recommended Flow Pressure	0.1 - 0.6 Mpa (1-6 Bar)
Rate of Flow	3.8 l/min (6 l/min or 1.9L/m available on request)
Water Inlet	Male thread G 1/2"
Dimensions	Height 152mm, Depth 145mm, Tap Ø 54mm, Hole Ø 35mm, Nosing 97mm, Discharge height 128mm
Warranty	24 Months
Product Code	SST56ACB (Mains)

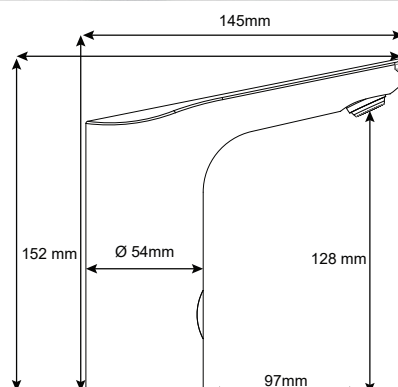

Spartan

Supply Specification	Faucet with electronics, electromagnetic valve, connecting hoses, angle valve with filter
Finish	Stainless steel construction
Water Temperature	For cold or premixed water (thermostatic mixing valve available)
Power Supply	Mains – 230V AC, 50 Hz (input) – 24V (output)
Control	Infrared sensor
Voltage	Mains 24V DC, 3W
Active Range	Standard 0.13 - 0.19 m, START / STOP program 0.25 - 7.75 secs
Recommended Flow Pressure	0.1 - 0.6 Mpa (1-6 Bar)
Rate of Flow	3.8 l/min (6 l/min or 1.9L/m available on request)
Water Inlet	Male thread G 1/2"
Dimensions	Height 141mm, Depth 115mm, Tap Ø 50mm, Hole Ø 35mm, Nosing 65mm, Discharge height 98mm
Warranty	24 Months
Product Code	SST91AC (Mains)

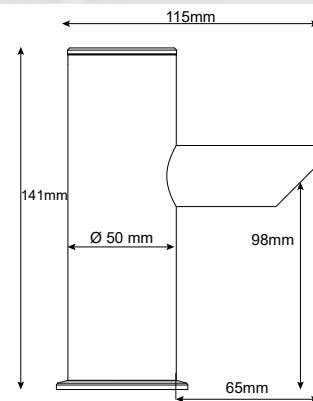

Spartan Piezo

Supply Specification	Faucet with electronics, electromagnetic valve, connecting hoses, angle valve with filter
Finish	Stainless steel construction
Water Temperature	For cold or premixed water (thermostatic mixing valve available)
Power Supply	Mains – 230V AC, 50 Hz (input) – 24V (output)
Control	Activation via soft touch Piezo button (10 second auto shut off)
Voltage	Mains 24V DC, 3W
Active Range	N/A
Recommended Flow Pressure	0.1 - 0.6 Mpa (1-6 Bar)
Rate of Flow	3.8 l/min (6 l/min or 1.9L/m available on request)
Water Inlet	Male thread G 1/2"
Dimensions	Height 157mm, Depth 115mm, Tap Ø 50mm, Hole Ø 35mm, Nosing 65mm, Discharge height 98mm
Warranty	24 Months
Product Code	SST91ACP (Mains)

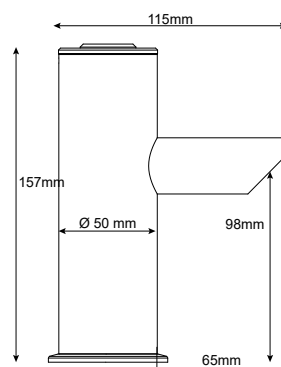

Nemo

Supply Specification	Faucet with swivel spout, electronics, thermostat & electromagnetic valve, rosette (2 pcs.), chrome cover (2 pcs.), filter (2 pcs.), allen key
Finish	Chrome
Temperature Regulation	Cold & hot water regulated by intergrated thermostatic mixer (hot & cold pressure must be equal)
Power Supply	Mains – 230V AC, 50 Hz (input) – 24V (output)
Control	Infrared sensor
Voltage	Mains – 24V DC, 3W
Active Range	Standard 0.6 - 0.75 m, START / STOP program 0.25 - 7.75 secs
Recommended Flow Pressure	0.1 - 0.6 Mpa (1-6 Bar)
Rate of Flow	3.8 l/min (6 l/min or 1.9L/m available on request)
Water Inlet	Male thread G 1/2"
Dimensions	Depth 244mm, Width 263mm
Warranty	24 Months
Product Code	SST25AC

SANELA 

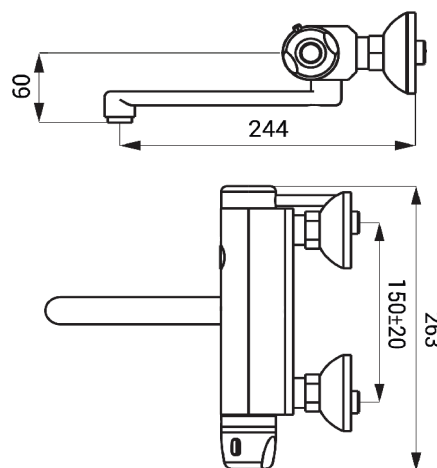

Spartan Soap

Supply Specification	Stainless steel spout with electronics, inlet hose, peristaltic pump for liquid soap and container for liquid soap 1l
Finish	Stainless steel construction
Power Supply	Mains – 230V AC, 50 Hz (input) – 24V (output)
Control	Infrared sensor
Voltage	Mains 24V DC, 3W
Active Range	0.14 - 0.2m START/STOP programme 1.3 - 13secs
Dispenser Type	Refillable liquid soap (1 litre)
Recommended Soap Viscosity	10 mPa*s - 5000 mPa*s (don't use chemical solvents and disinfectant)
Dimensions	Height 109mm, Depth 92mm, Tap Ø 40mm, Hole 32-34mm, Nosing 69mm, Discharge height 75mm
Warranty	24 Months
Product Code	SSS91AC (Mains)

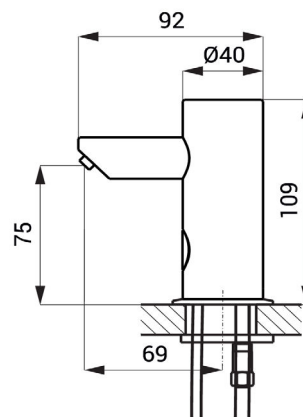
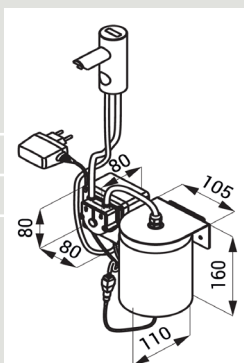

SPL

Spartan Wall Mount

Supply Specification	Faucet with electronics, electromagnetic valve, mounting plate, allen key
Finish	Stainless steel construction
Water Temperature	For cold or premixed water (thermostatic mixing valve available)
Power Supply	Mains – 230V AC, 50 Hz (input) – 24V (output)
Control	Infrared sensor
Voltage	Mains 24V DC, 3W
Active Range	Standard 0.11 - 0.15 m, START / STOP program 0.25 - 7.75 secs
Recommended Flow Pressure	0.1 - 0.6 Mpa (1-6 Bar)
Rate of Flow	3.8 l/min (6 l/min or 1.9L/m available on request)
Water Inlet	Male thread G 1/2"
Dimensions	Tap Ø 50mm, Nosing 210mm, Discharge height 300mm min from bottom of sink, Discharge depth 170mm
Warranty	24 Months
Product Code	SST43AC (Mains)

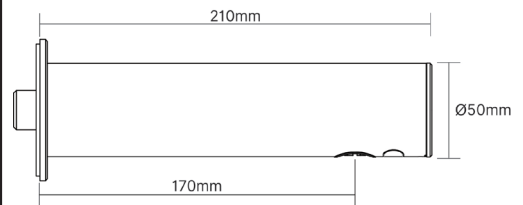

Spartan Wall Mount Soap

Supply Specification	Stainless steel spout with electronics, grip plate, inlet hoses and cables in a protective tube 80 cm, peristaltic pump for liquid soap and container for liquid soap 1l
Finish	Stainless steel construction
Power Supply	Mains – 230V AC, 50 Hz (input) – 24V (output)
Control	Infrared sensor
Voltage	Mains 24V DC
Active Range	0.11 - 0.15m, START/STOP programme 1.3 - 13secs
Dispenser Type	Refillable liquid soap (1 litre)
Recommended Soap Viscosity	10 mPa*s - 5000 mPa*s (don't use chemical solvents and disinfectant)
Dimensions	Tap Ø 50mm, Nosing 164mm, Discharge height 300mm min from bottom of sink, Discharge depth 123mm
Warranty	24 Months
Product Code	SSS83WMAC (Mains)

